

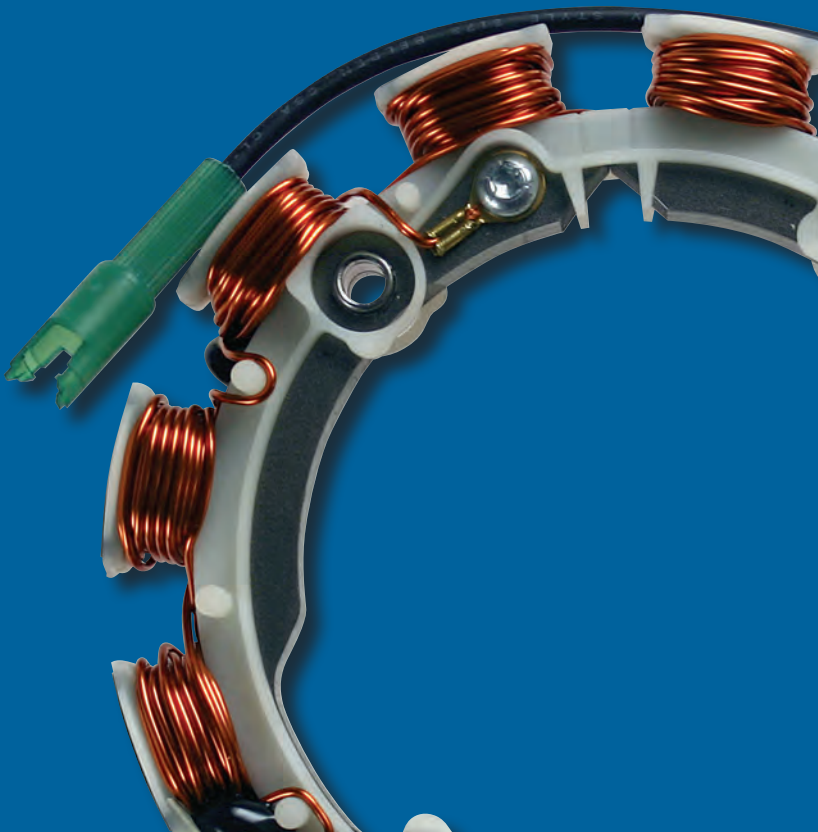

ALTERNATOR

Specifications



Meters



Diagnostic Tool



19468 DC SHUNT

The DC shunt is a very useful tool, especially when working with higher amperages. To use, the electrical system must be opened and the shunt installed on the negative terminal of the battery. In this position, all energy going into and coming out of the battery must pass through the shunt. The shunt is designed to read voltage drops due to the resistance of the metal between the two meter lead connections. The resistance value has been carefully set to allow the meter to use the millivolt scale. In use, 1 millivolt equals 1 amp. Dealing with millivolts is much safer than dealing with amps.

To identify an alternator system, inspect wire or wires that come from under or behind the blower housing.

- A single wire with no diode is generally, but not always, an AC only system
- A single wire with a diode is generally a DC only system. The diode rectifies AC to DC for battery charging. This system is unregulated in that the energy delivered to the battery is totally dependent on engine speed
- A red wire with a diode and black wire without a diode is a Dual Circuit system that offers DC for battery charging and AC to power lights
- A single wire feeding an electronic component (regulator/rectifier) is a rectified and regulated system which is less dependent on engine speed than the DC only system
- Two wires of the same color feeding a regulator/rectifier is a rectified and regulated system that offers even more energy

Most Digital Multi Meters (DMM) are able to read up to 10 amps for short periods of time. At or above 10 amps, consider using a DC shunt or a clamp on type meter to prevent meter damage.

When measuring energy being returned to the battery, Briggs & Stratton specifications are provided in DC amps. The power is initially provided from the stator as AC and must go through a rectification process. If the battery will not charge, the fault may be the battery, rectifier (diode), regulator/rectifier or stator. A troubleshooting flow chart will usually start at the battery and work backwards. As there is no bench test for regulator/rectifiers, test AC output from the stator. If the battery and AC output are OK, replace the regulator/rectifier by process of elimination.

AC tests are made for AC volts while tests for DC charging output are made in DC amps. One or both will be used to check the health of all Briggs & Stratton alternator systems.

HOW TO USE

These cards supply information on the different alternator systems provided by Briggs & Stratton. Identify the system being tested by the wire or wires that extend from behind the flywheel. Record the number and color of the wires and the color and general type of connector the wires terminate in.

At the top of each card is the system name displayed on that card followed by a picture of the wire(s), color and connector. If a regulator/rectifier is part of the system, a picture will be displayed of it. From this information, determine which system is installed on the engine to be tested. Once the system is identified, turn the card over. The first graphic is how the system would be installed in the simplest manner. The next graphic is how to hook up the test meter. Test specifications to expect follow at the bottom of the page.

TESTING

Unregulated charging systems always deliver the same amount of energy to the battery (based on rpm) whether it requires charge or not.

Regulated charging systems are designed to provide charge to the battery based on its need.

The output from the unregulated system is predictable as long as the rpm is held steady.

Regulated system output will vary based on the battery state of charge. After activating the starter motor to start the engine, charge rate will typically be high as the alternator replaces the energy used by the starter. The charge rate will reduce slowly as the battery state of charge levels off. This means that test specifications can be a moving target. The test specifications for regulated systems are generally stated as a range such as 1 to 10 amps DC or 3 to 16 amps DC.

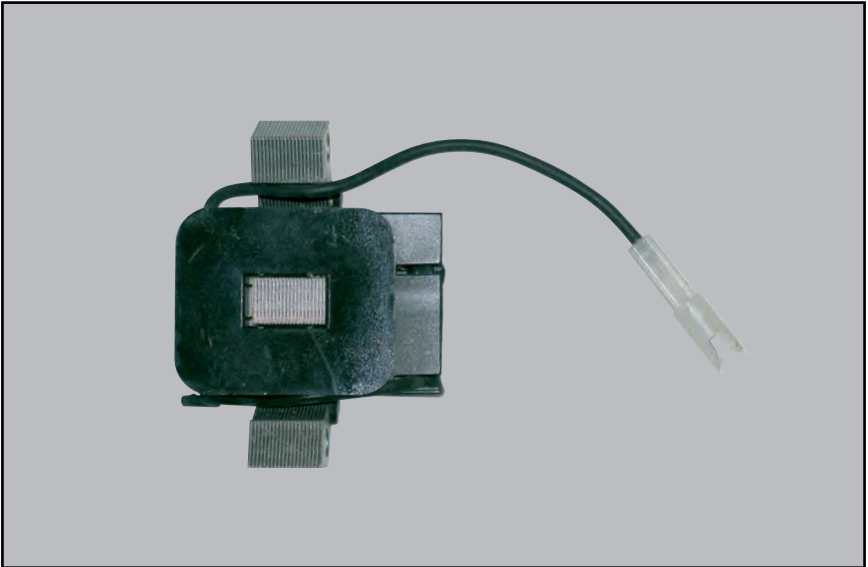

Part	Part Number
Stator	794103

DC Only

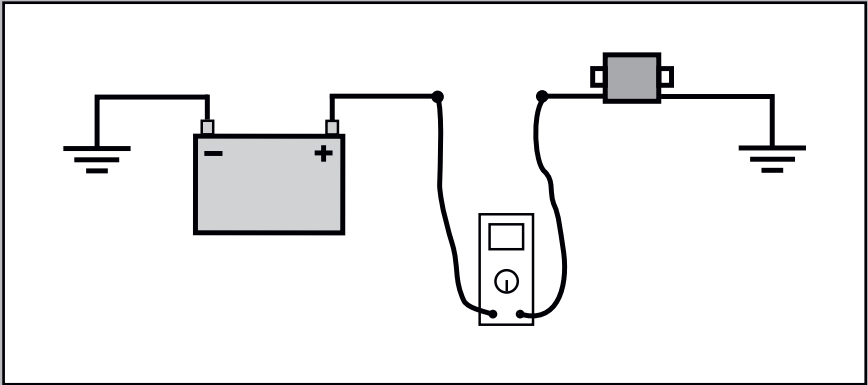
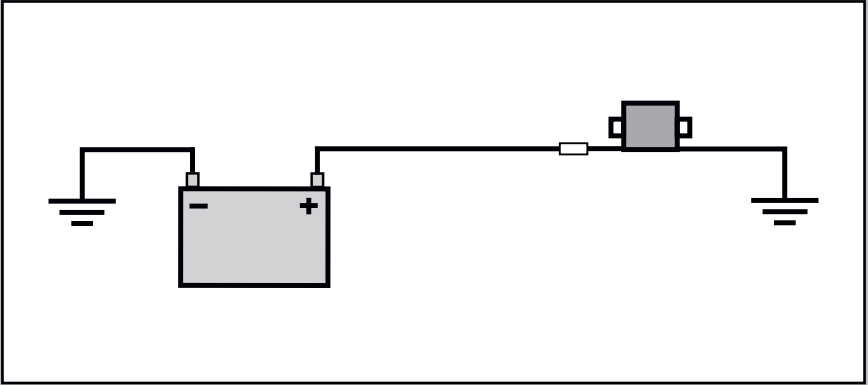

Test Specifications @ 2800 rpm	
AC volts	NA
DC amps	.5 adc minimum
DC amps (DOV® engines with an aluminum flywheel)	.4 adc minimum

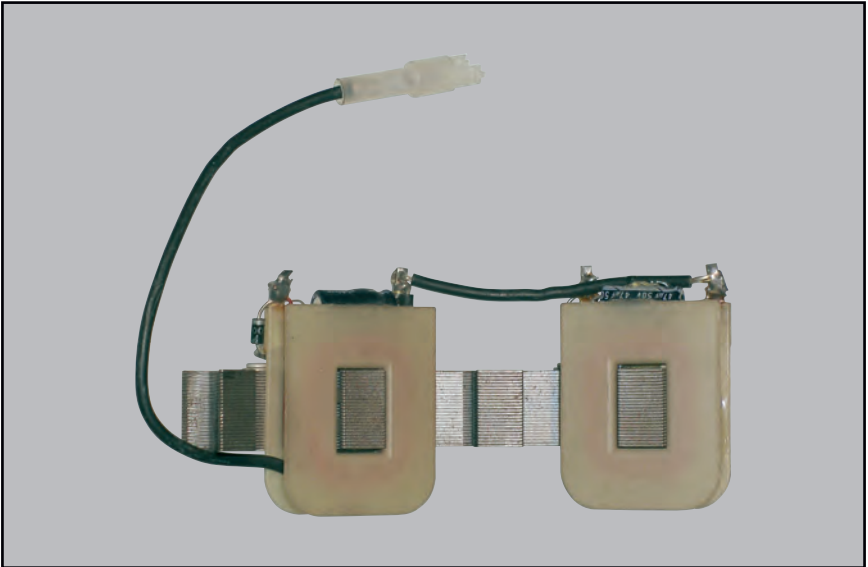

Part	Part Number
Stator	397880

DC Only

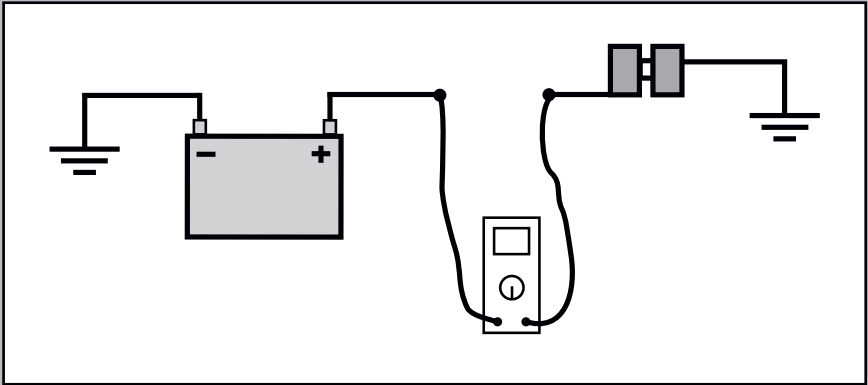
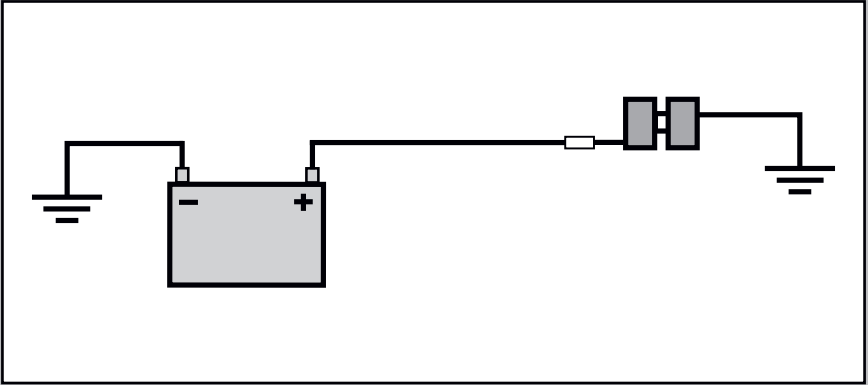

Test Specifications @ 2800 rpm	
AC volts	NA
DC amps	.5 adc



Part	Part Number
Stator	793640
Diode	391507

DC Only

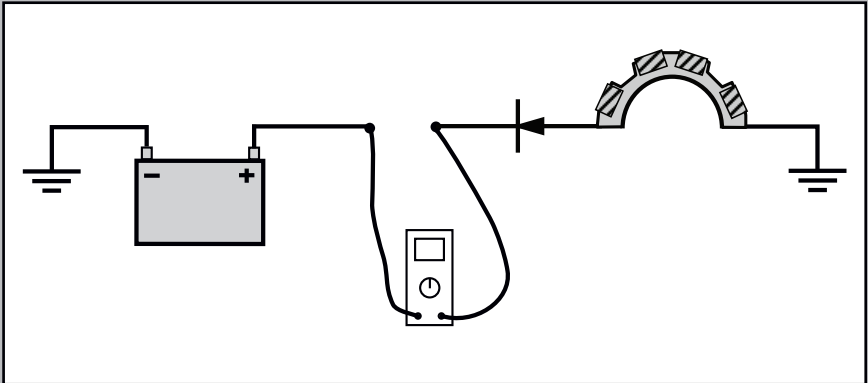
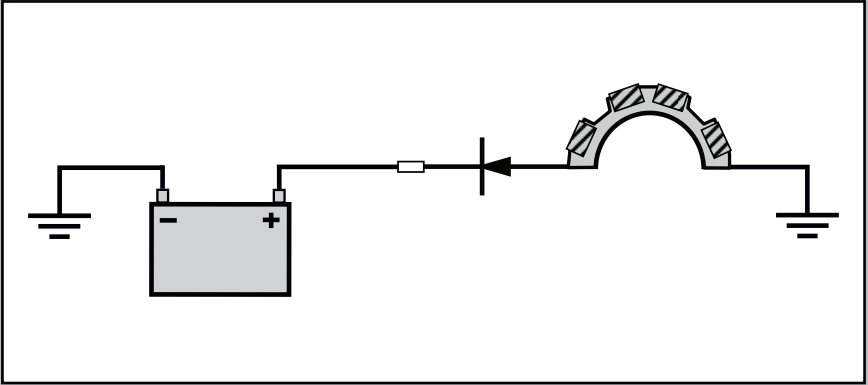

Test Specifications @ 3600 rpm

AC volts	NA
DC amps	1.5 adc

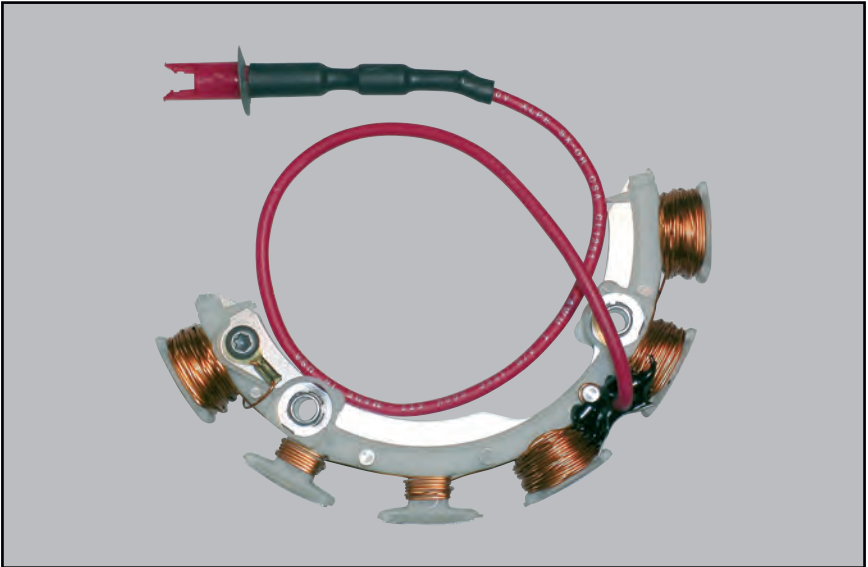

Part	Part Number
Stator	695730
Diode	391507

DC Only

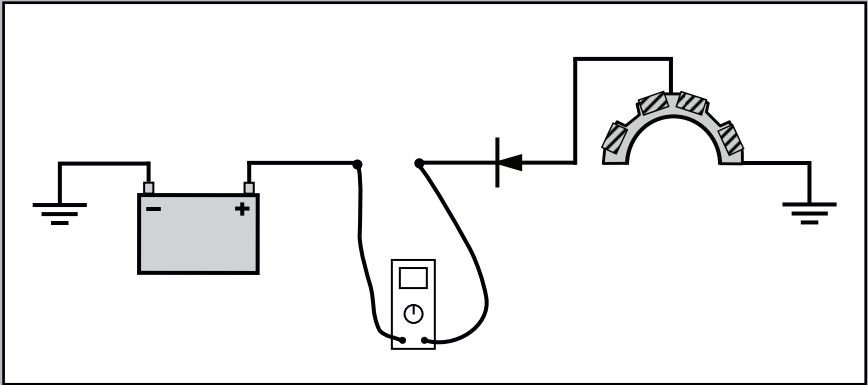
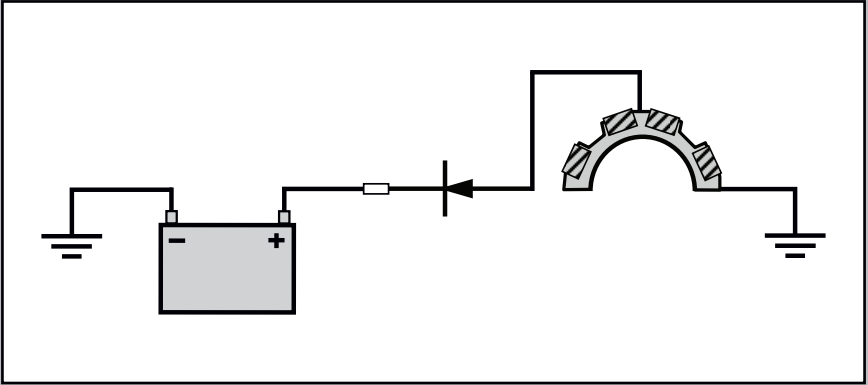

Test Specifications @ 3600 rpm

AC volts	NA
DC amps	3.0 adc

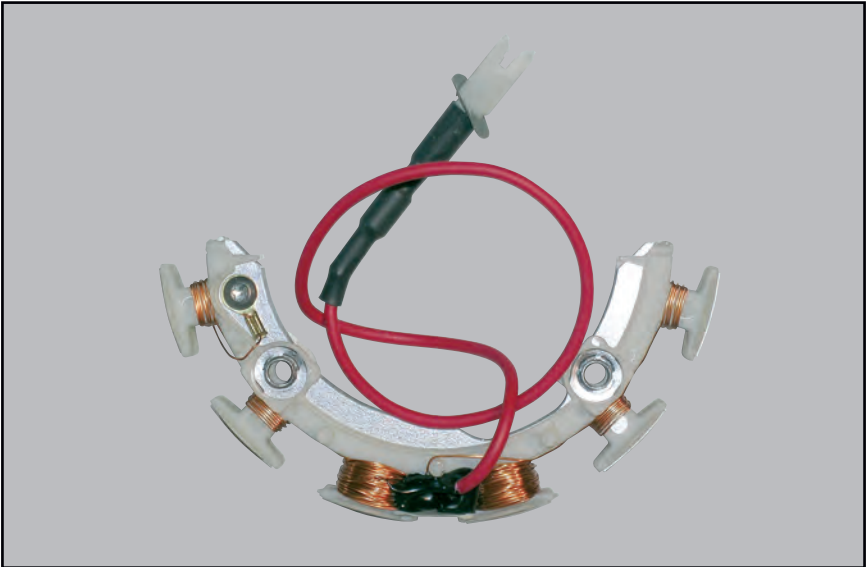

Part	Part Number
Stator	694457
Diode	391507

DC Only

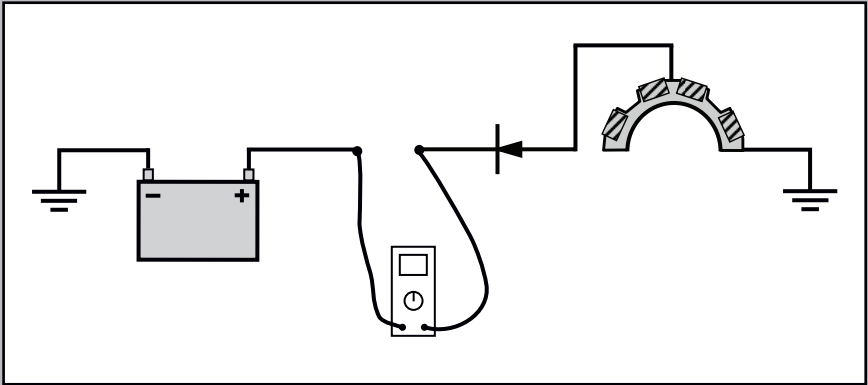
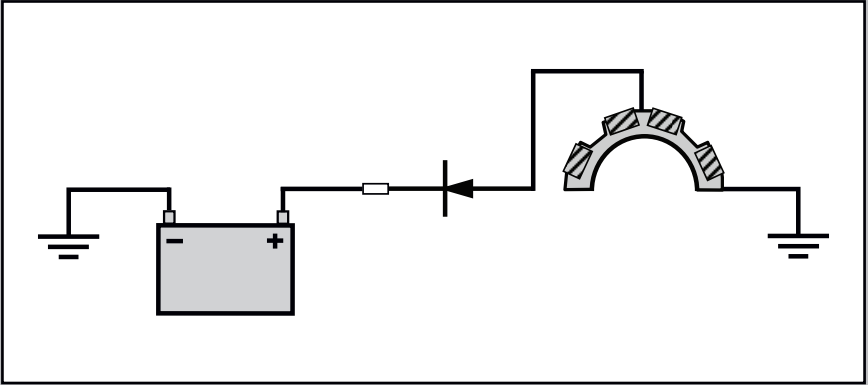

Test Specifications @ 3600 rpm

AC volts	NA
DC amps	1.5 adc



Part	Part Number
Stator	696578
Diode	391507

DC Only

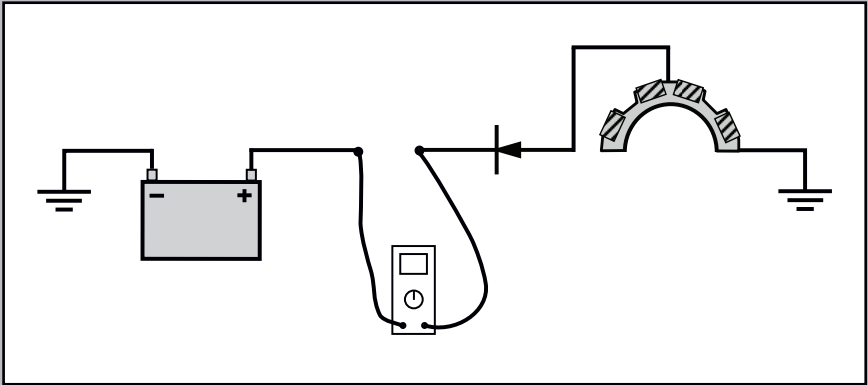
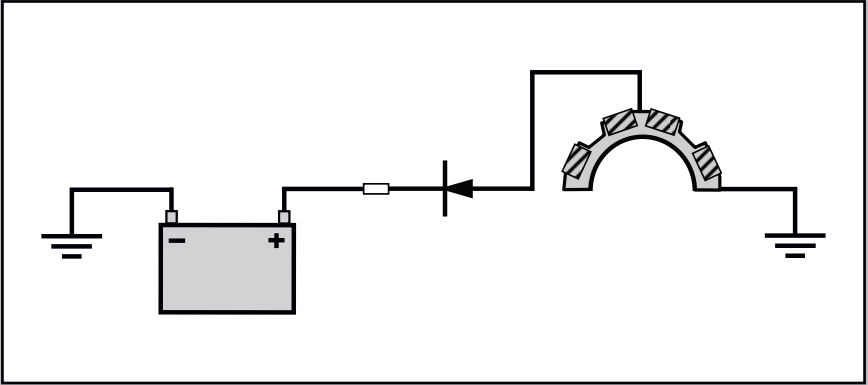

Test Specifications @ 3600 rpm	
AC volts	NA
DC amps	3.0 adc



Part	Part Number
Stator	393809
Diode	391507
Harness	393422

DC Only

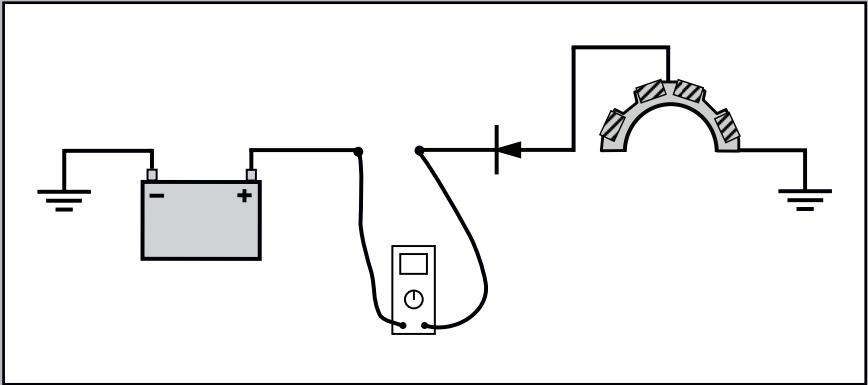
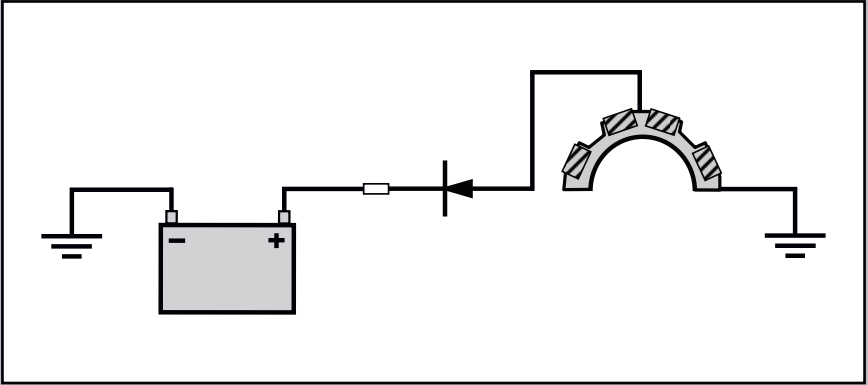

Test Specifications @ 3600 rpm

AC volts	NA
DC amps	3.0 adc



Part	Part Number
Stator	391595

AC Only

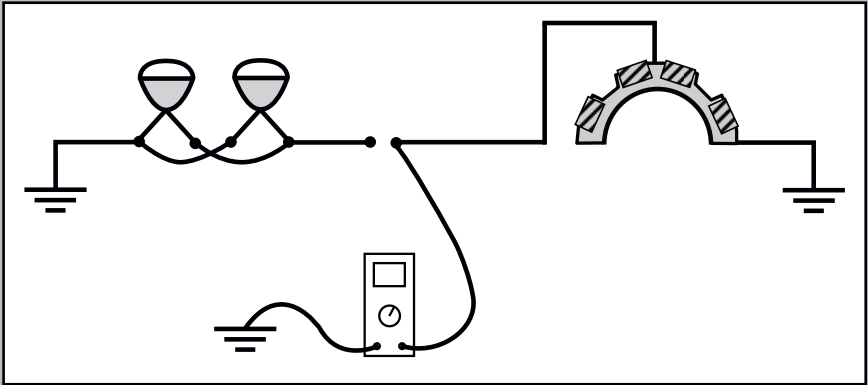
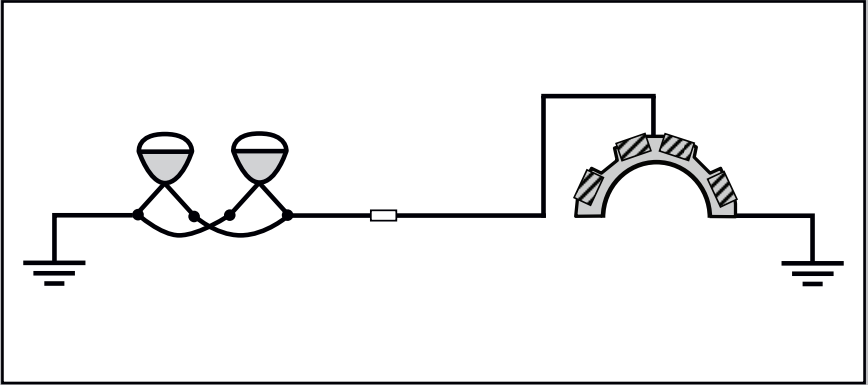

Test Specifications @ 3600 rpm

AC volts	14 vac
DC amps	NA

Dual Circuit Rectified or Regulated

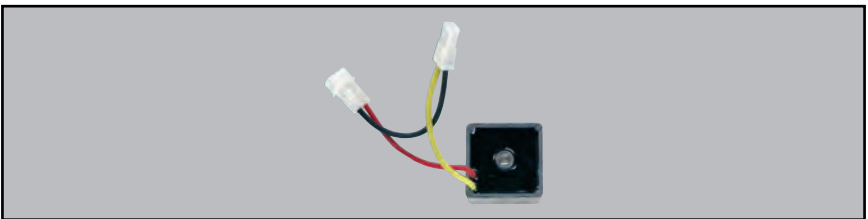

Part	Part Number
Stator	698230
Diode	319507
Regulator/Rectifier	790292

Dual Circuit

Rectified or Regulated

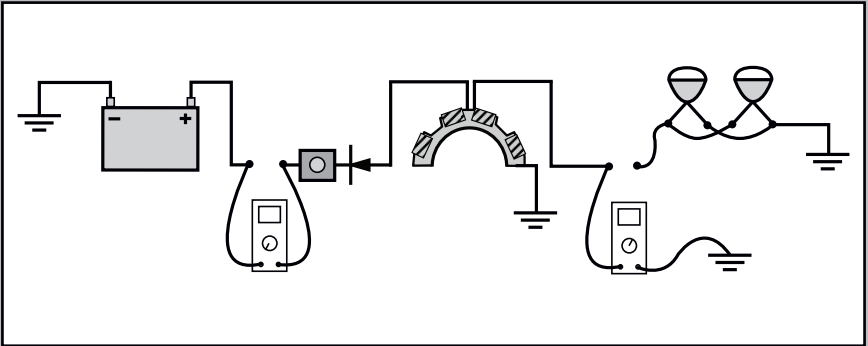
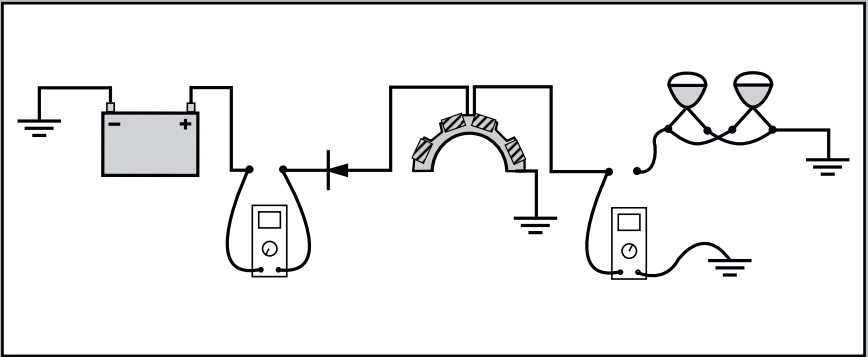
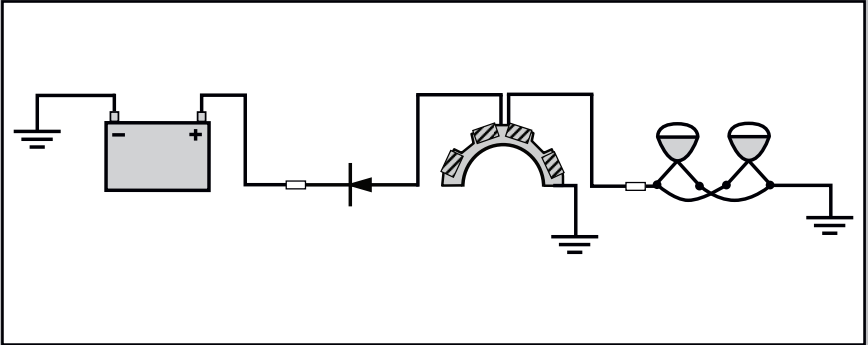

Test Specifications @ 3600 rpm

AC volts	14 vac
DC amps	3 adc
DC amps through regulator	5 adc

Dual Circuit Rectified or Regulated

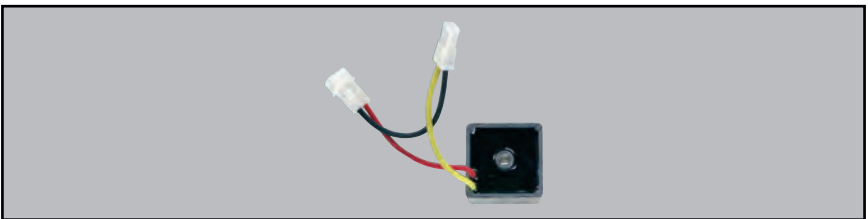
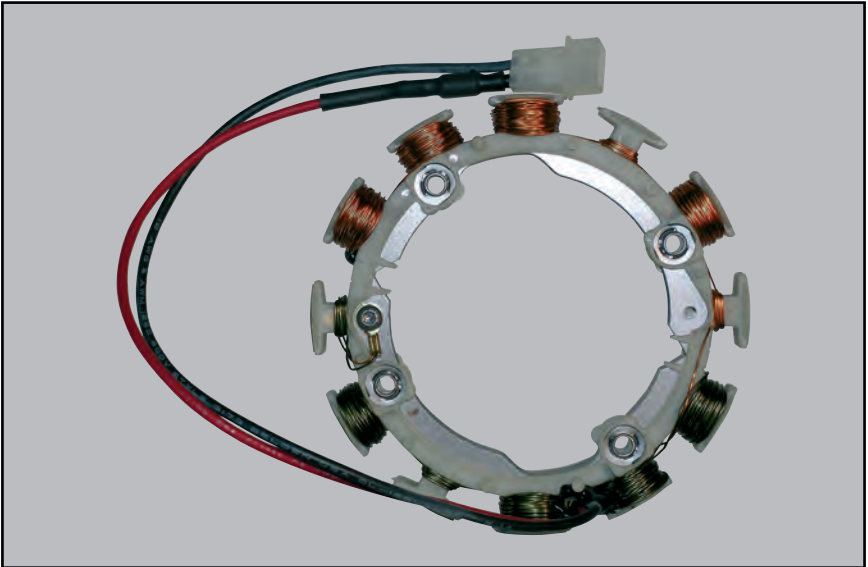

Part	Part Number
Stator	696742
Diode	319507
Regulator/Rectifier	790292

Dual Circuit

Rectified or Regulated

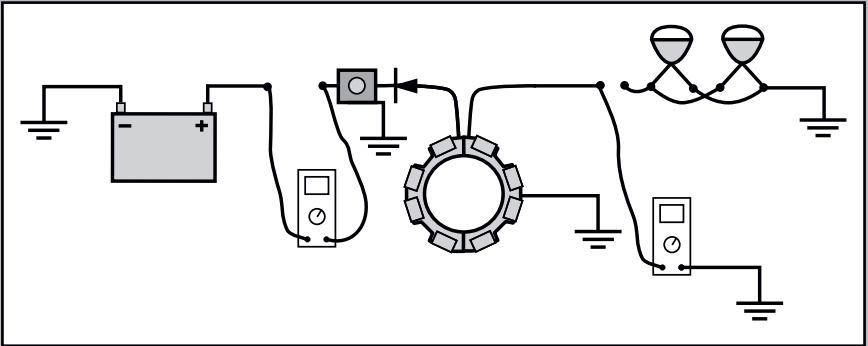
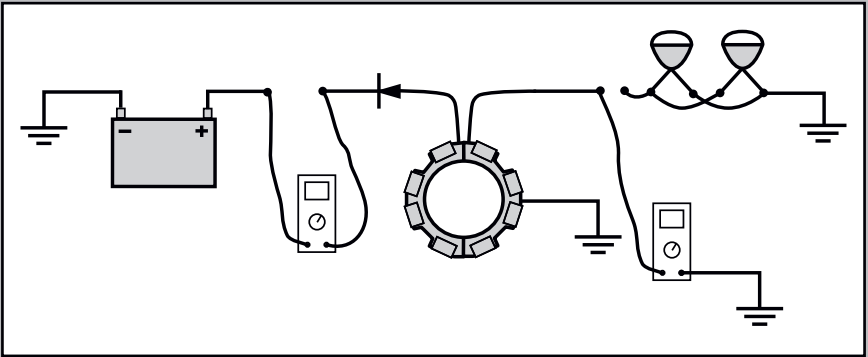
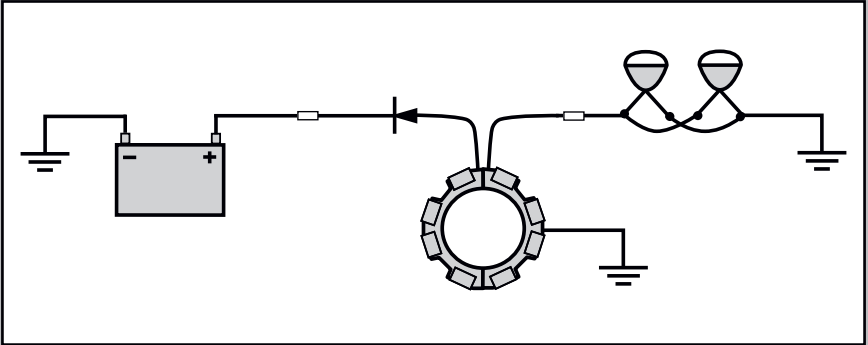

Test Specifications @ 3600 rpm

AC volts	14 vac
DC amps	3 adc
DC amps through regulator	5 adc

Dual Circuit Rectified or Regulated

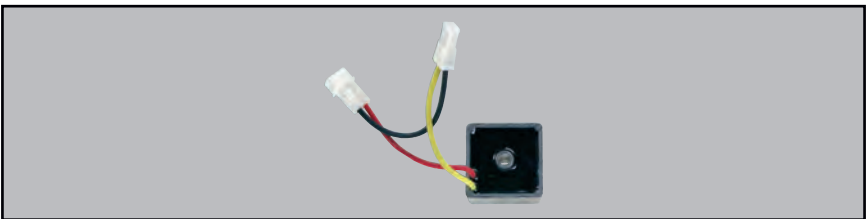

Part	Part Number
Stator	696459
Diode	319507
Regulator/Rectifier	790292

Dual Circuit

Rectified or Regulated

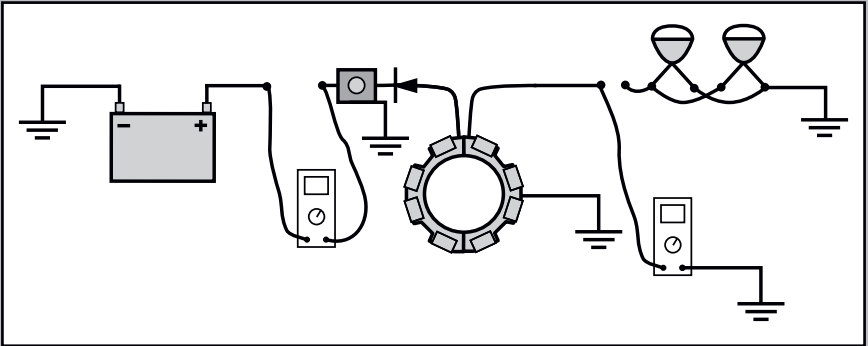
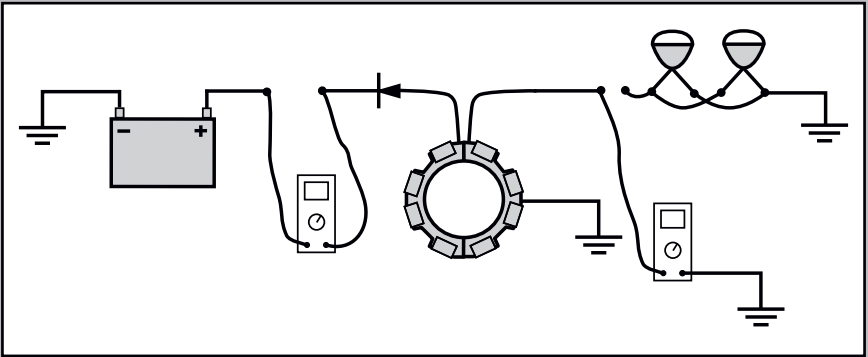
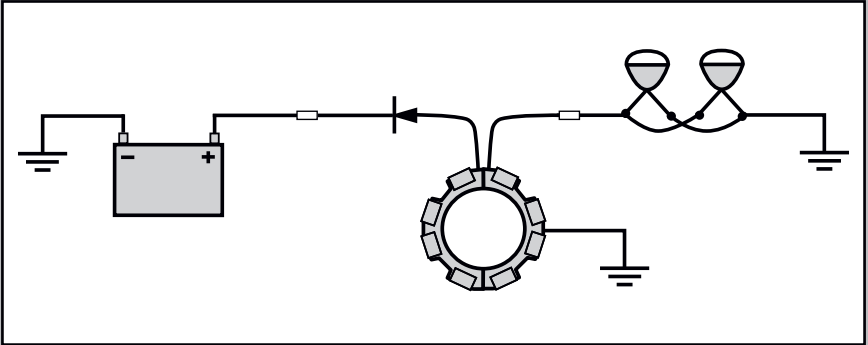

Test Specifications @ 3600 rpm

AC volts	14 vac
DC amps	3 adc
DC amps through regulator	5 adc

Dual Circuit Rectified or Regulated

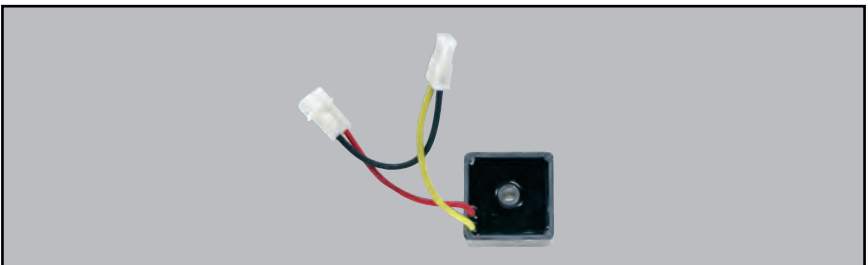
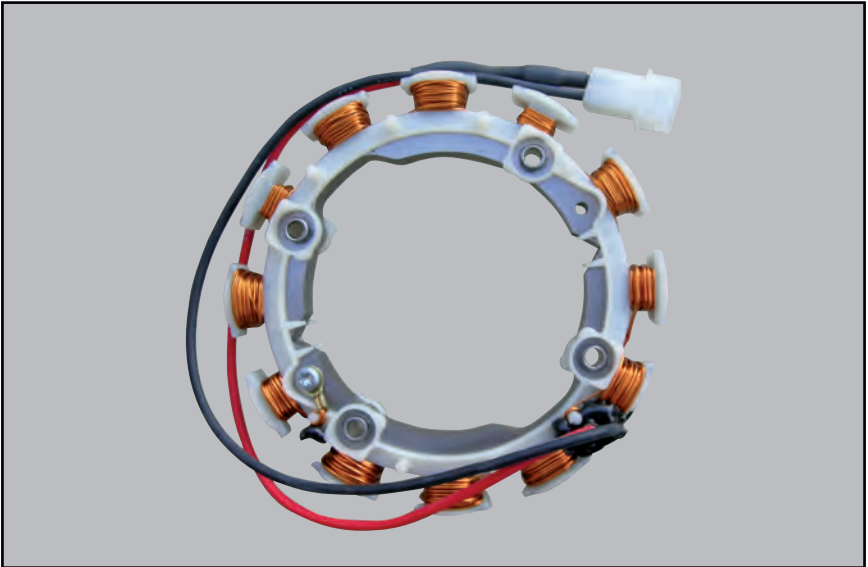

Part	Part Number
Stator	793118
Diode	391507
Regulator/Rectifier	790292

Dual Circuit

Rectified or Regulated

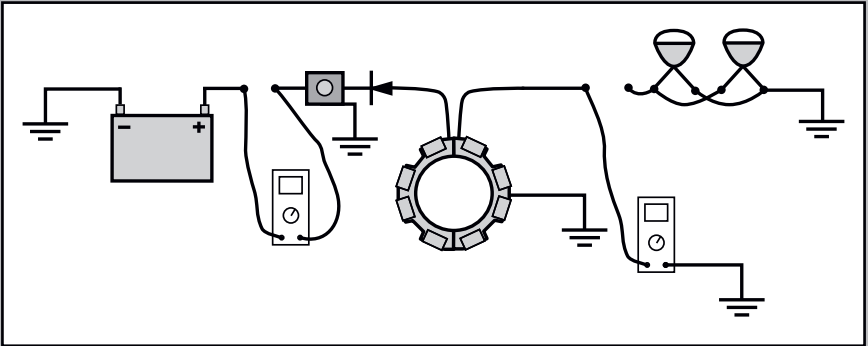
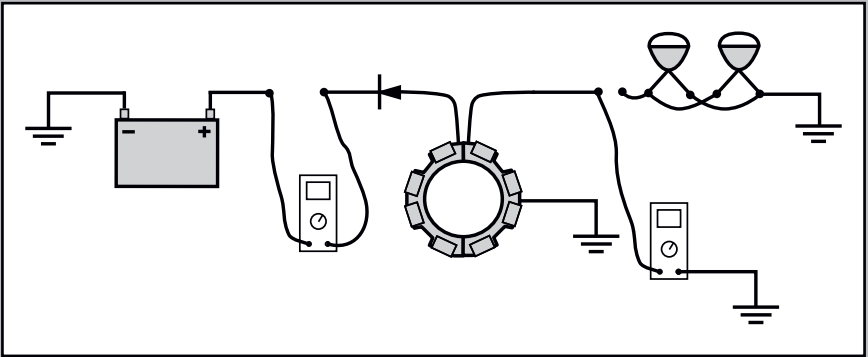
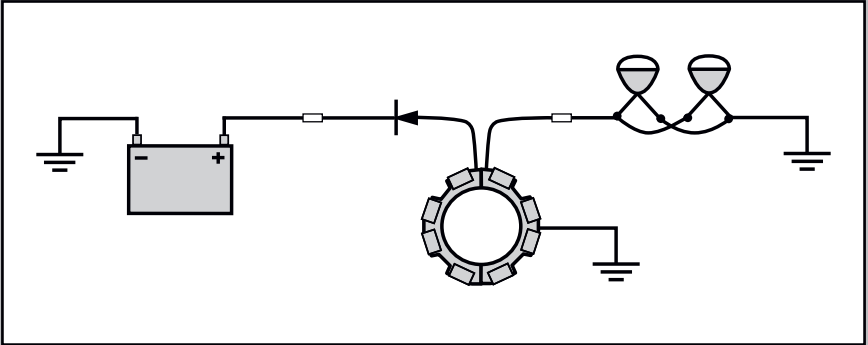

Test Specifications @ 3600 rpm

AC volts	14 vac
DC amps	3 adc
DC amps through regulator	5 adc

4 Amp Regulated - MHI

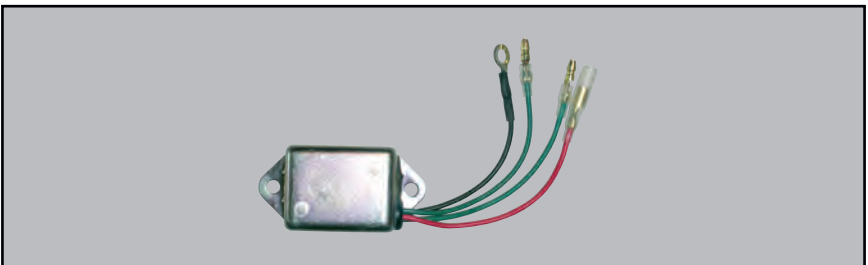
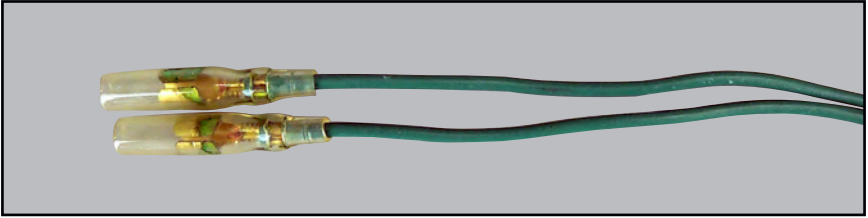

Part	Part Number
Stator	715255
Regulator	715200

4 Amp Regulated - MHI

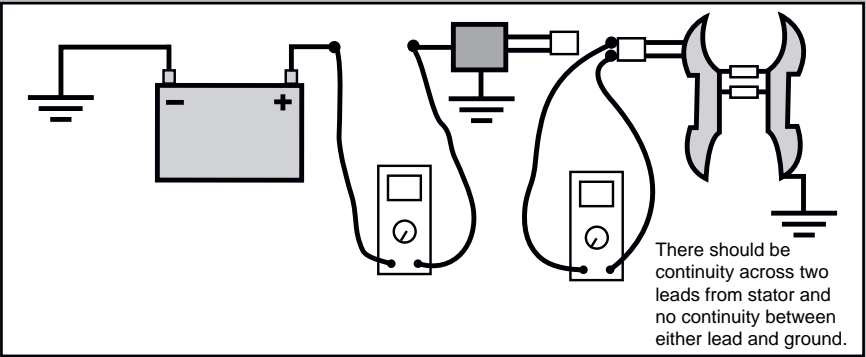
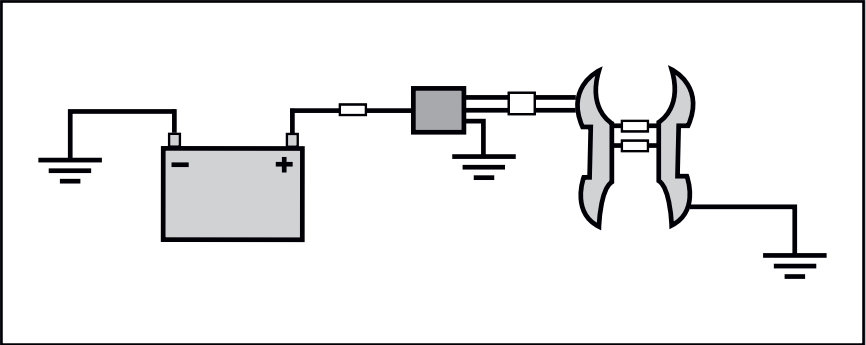

Test Specifications @ 3600 rpm

AC volts	NA
DC amps	1→4 adc

9 Amp without battery

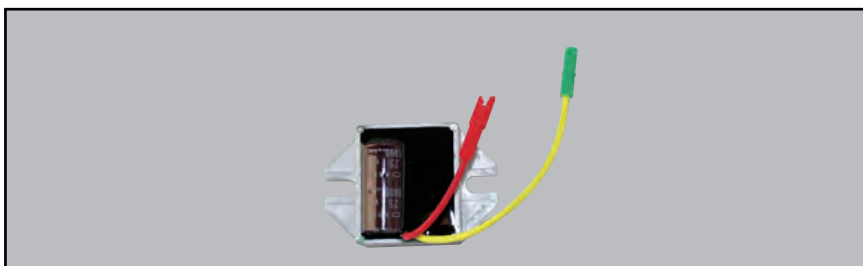
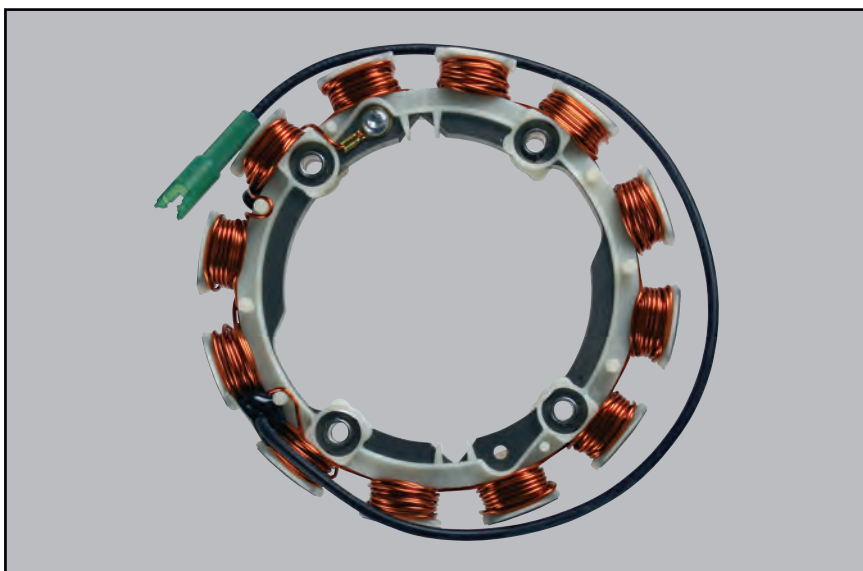

Part	Part Number
Stator	698314
Regulator	698315

9 Amp without battery

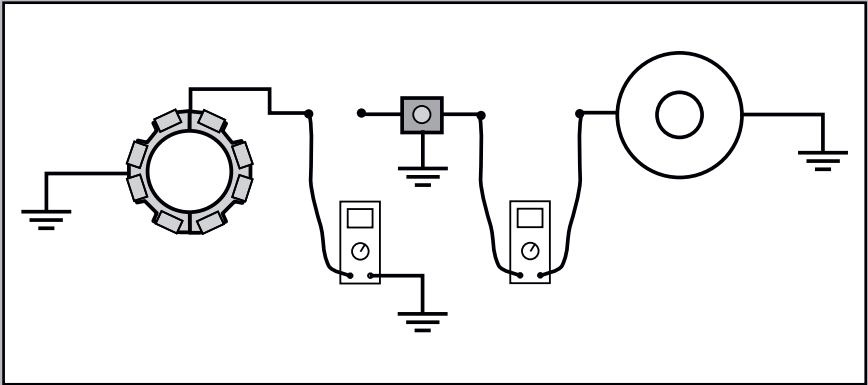
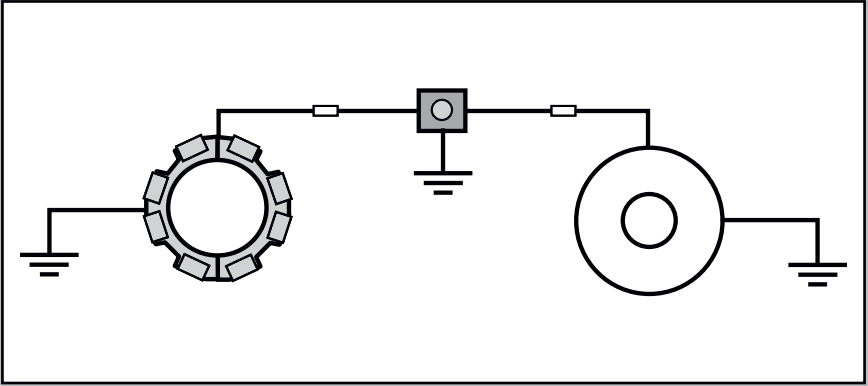

Test Specifications @ 3600 rpm

AC volts	40 vac
DC amps	1→9 adc

5 or 9 Amp Regulated

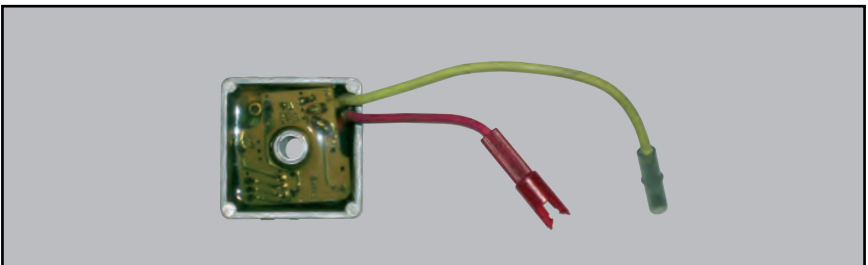
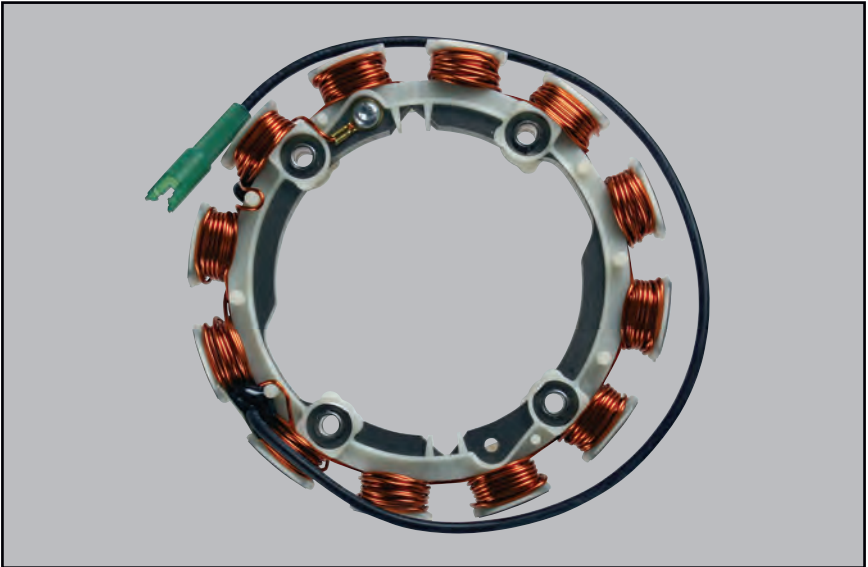

Part	Part Number
Stator	698314
Regulator	794360

5 or 9 Amp Regulated

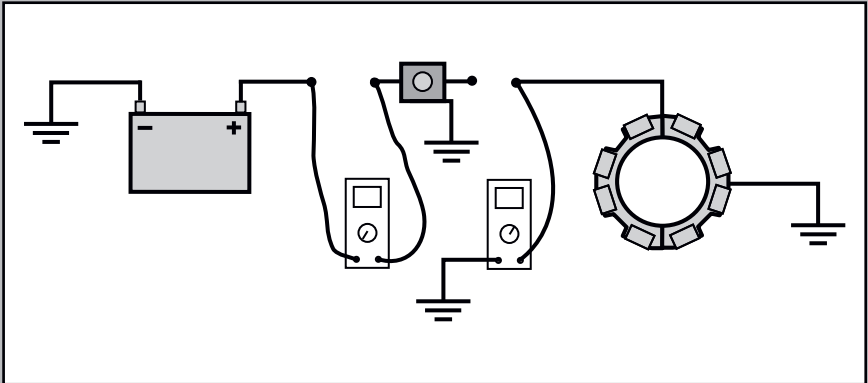
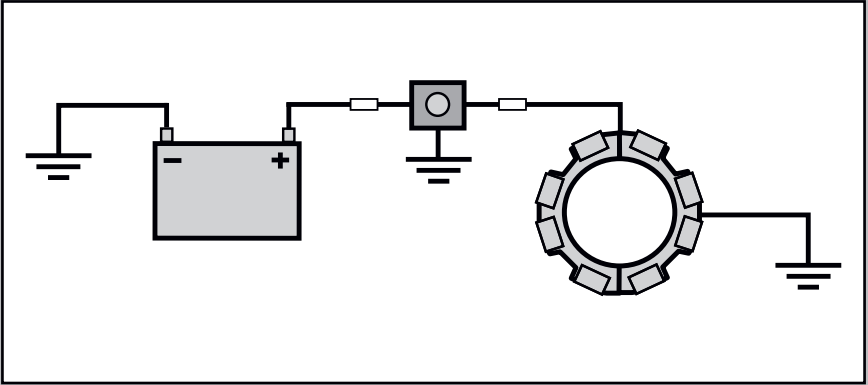

Test Specifications @ 3600 rpm	
AC volts	
5 amps system	28 vac
9 amps system	40 vac
DC amps	
5 amps system	5 adc
9 amps system	9 adc

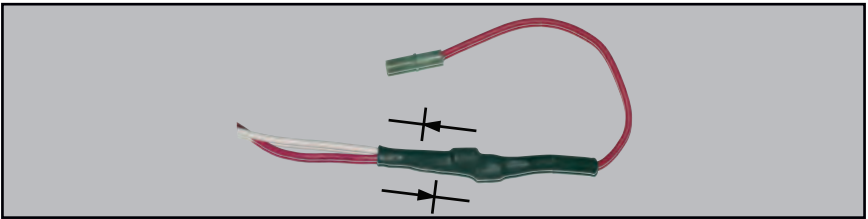
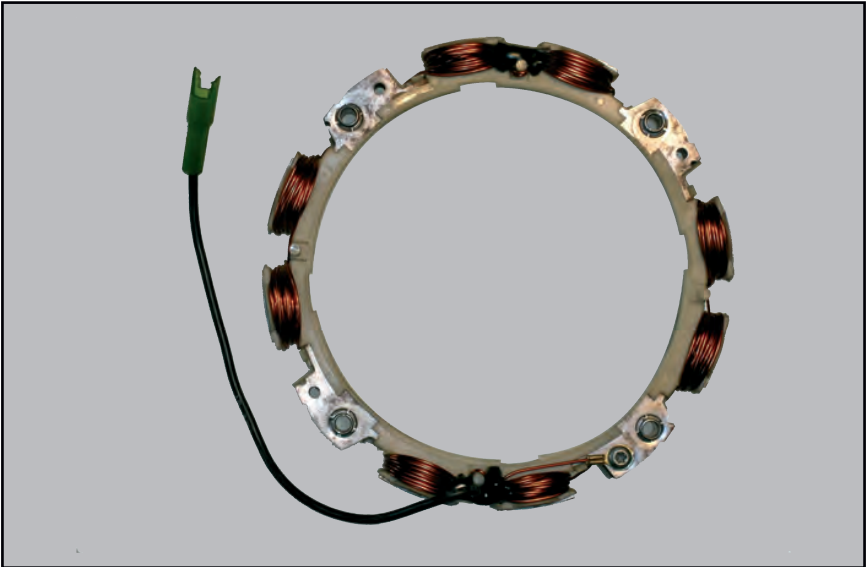
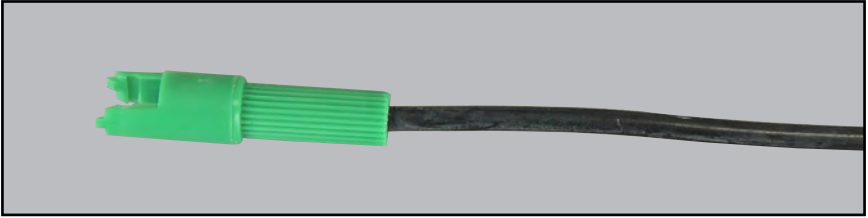

Part	Part Number
Stator	696457
Harness	691955
Diode	391507
DC Shunt	19468

Tri-Circuit

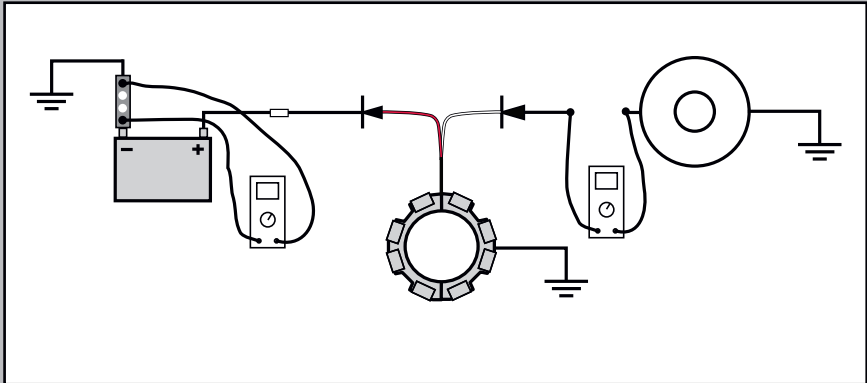
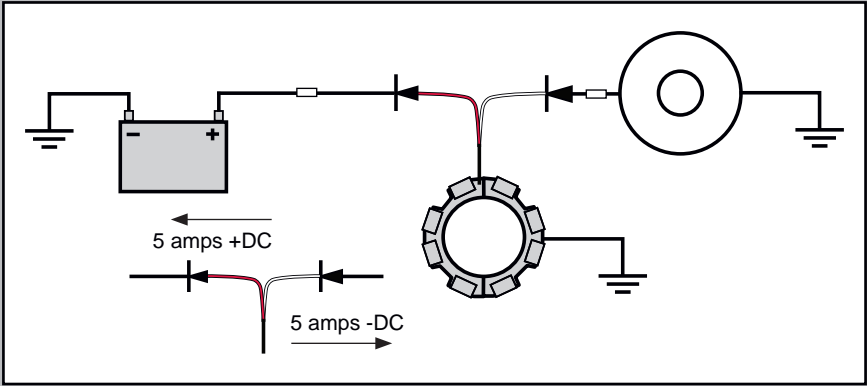

Test Specifications @ 3600 rpm

AC volts	28 minimum
DC amps at shunt	5 minimum

5 or 9 Amp Regulated

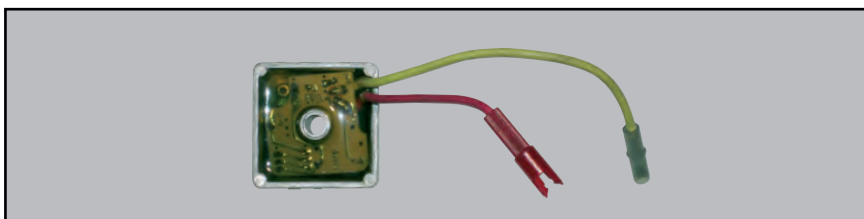

Part	Part Number
Stator	696457
Regulator/Rectifier	794360

NOTE:

The difference between the 5 and 9 amp regulated systems is the size of the magnets on the flywheel. Small on the 5 and large on the 9.

5 or 9 Amp Regulated

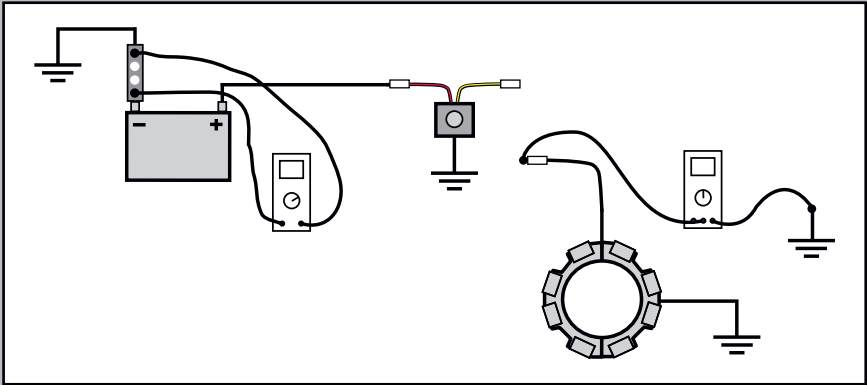
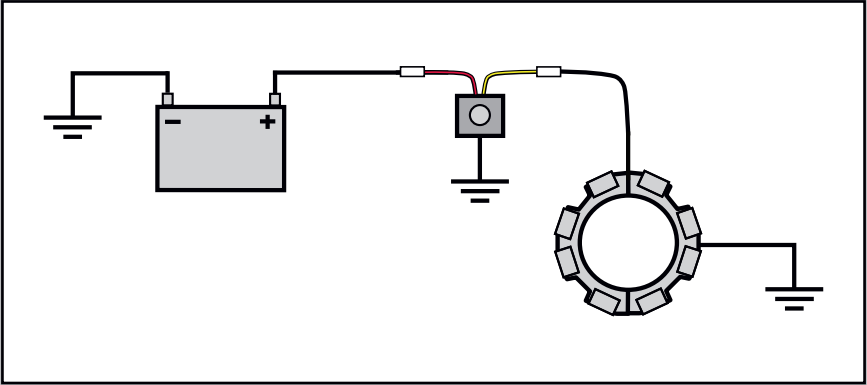

Test Specifications @ 3600 rpm

AC volts	
5 amps system	28 vac
9 amps system	40 vac
DC amps at shunt	
5 amps system	5 adc
9 amps system	9 adc

5 Amp Regulated without battery

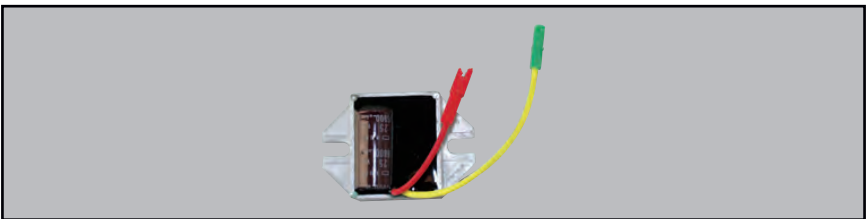
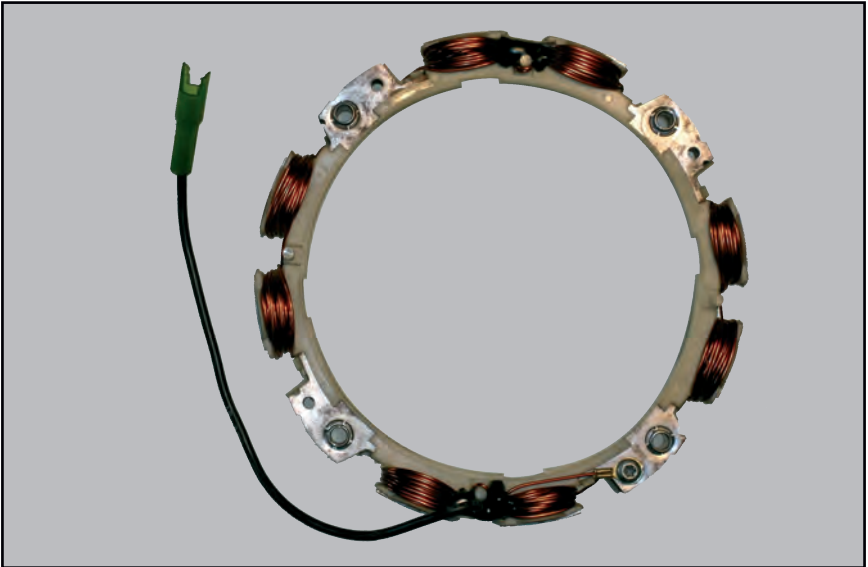
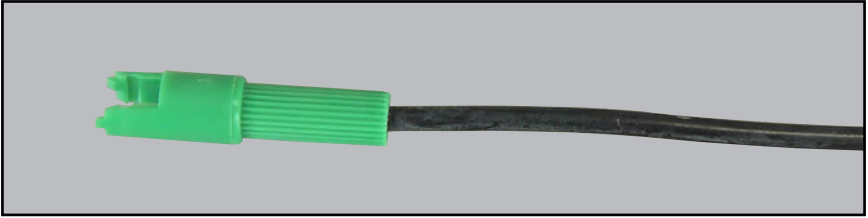

Part	Part Number
Stator	696457
Regulator/Rectifier	698315

5 Amp Regulated without battery

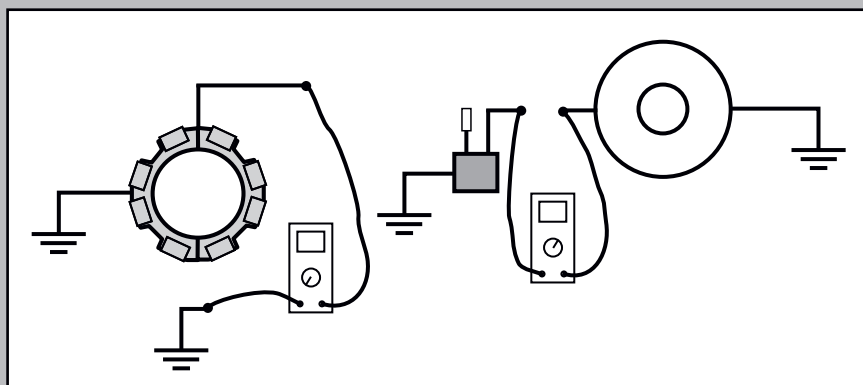
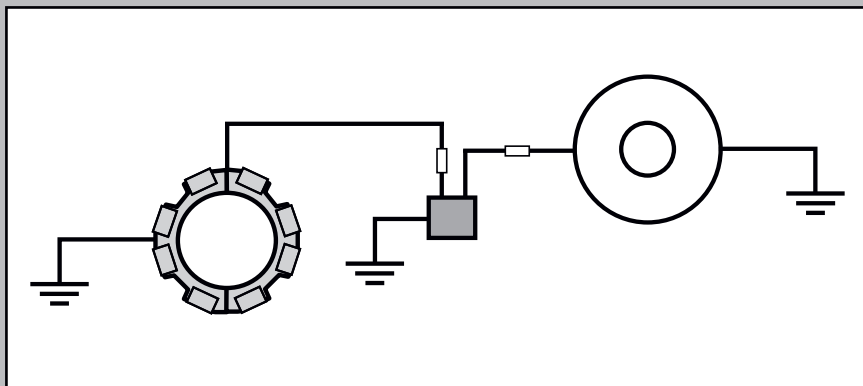

Test Specifications @ 3600 rpm

AC volts	28 vac
DC amps	5 adc

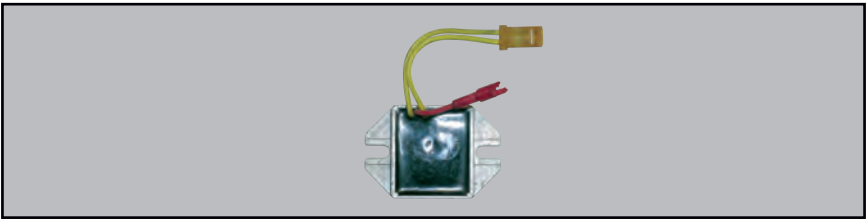
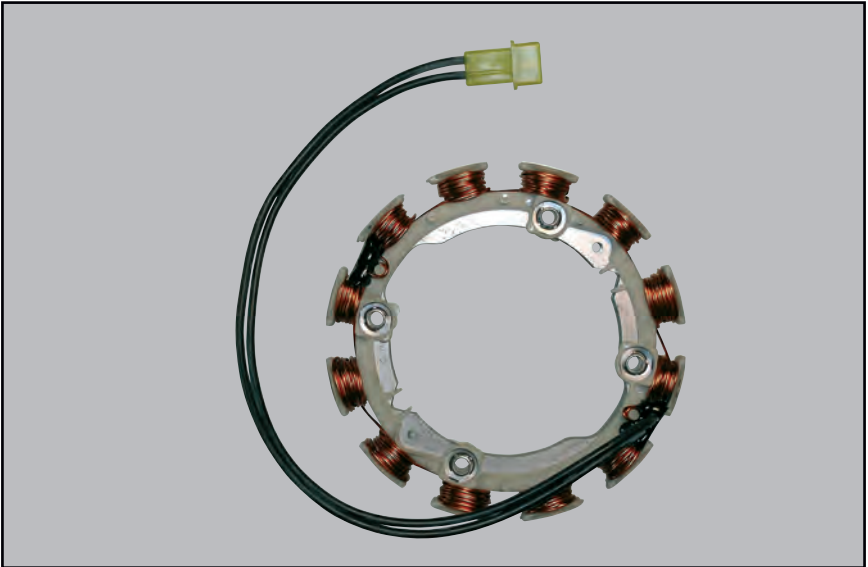
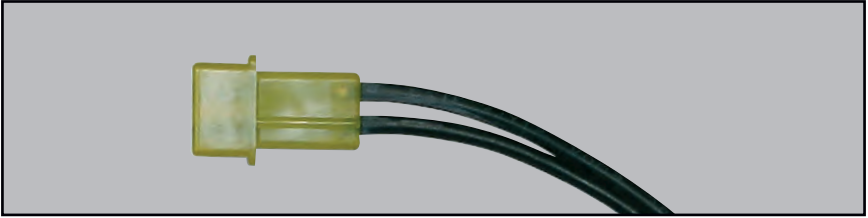

Part	Part Number
Stator	695466
Regulator/Rectifier	691185

10 Amp Regulated

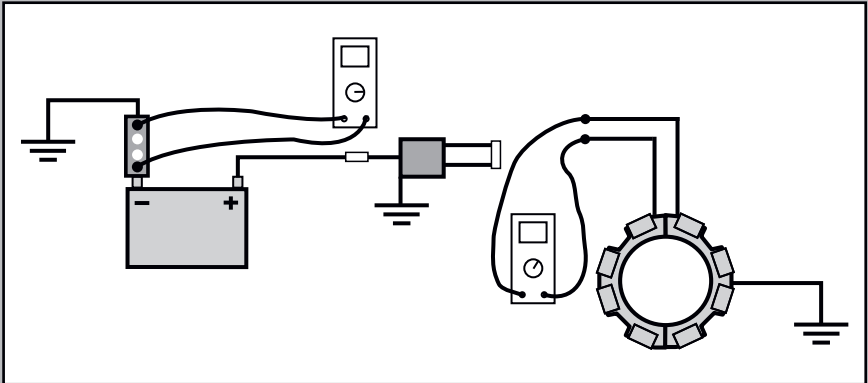
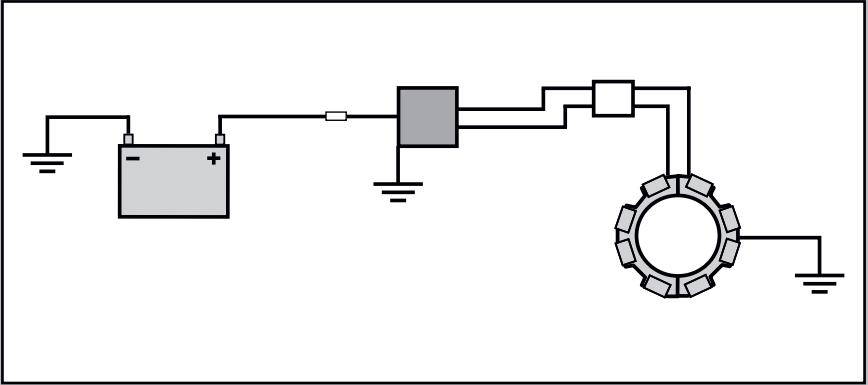

Test Specifications @ 3600 rpm

AC volts	20 vac
DC amps	1→10 adc

10 Amp Regulated - MHI

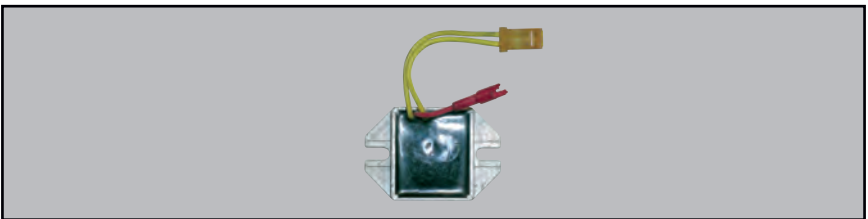
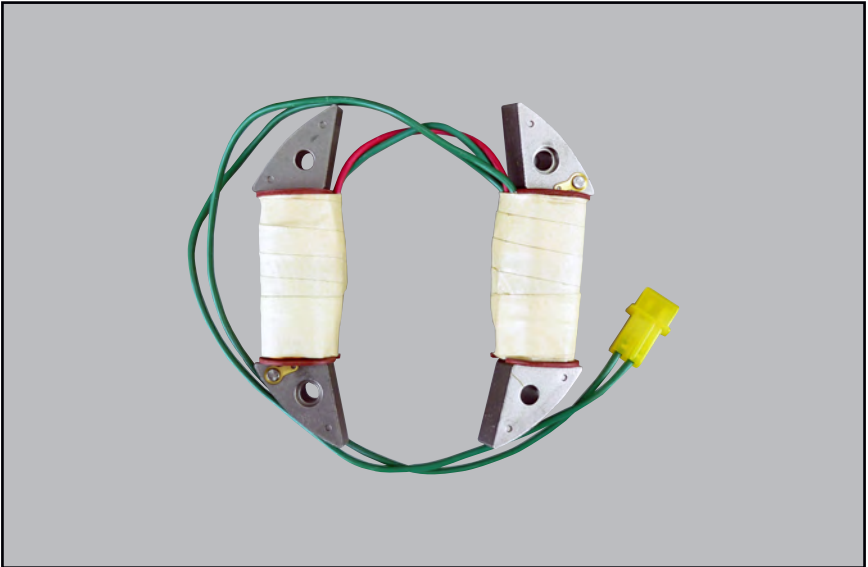
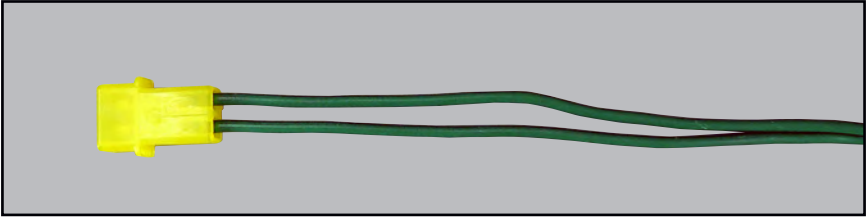

Part	Part Number
Stator	715194
Regulator	691185
Connector, yellow	399916

10 Amp Regulated

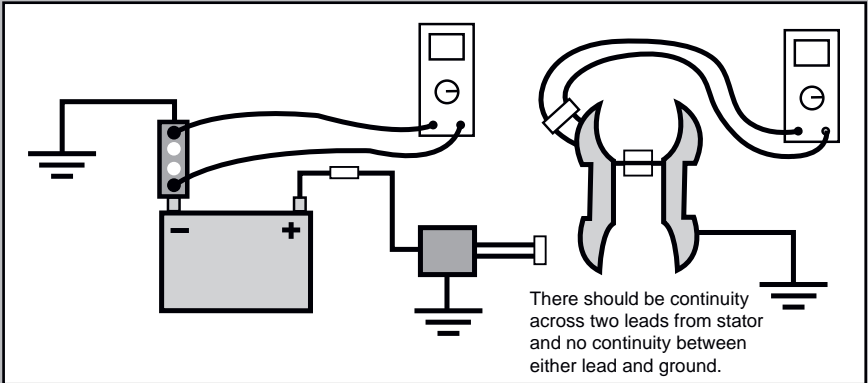
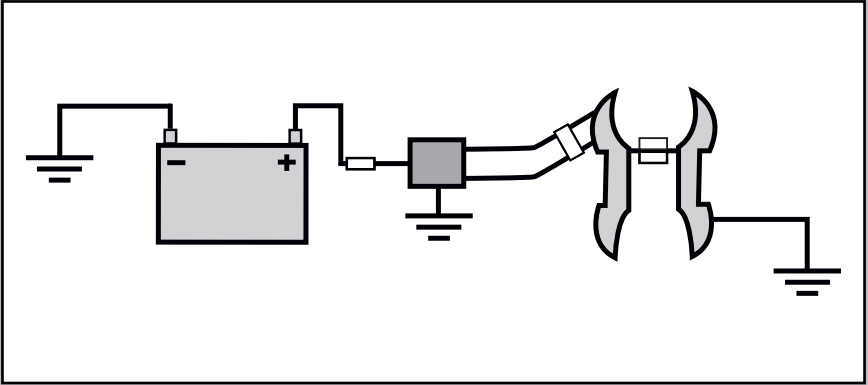

Test Specifications @ 3600 rpm

AC volts	NA
DC amps at shunt	1 → 10 adc

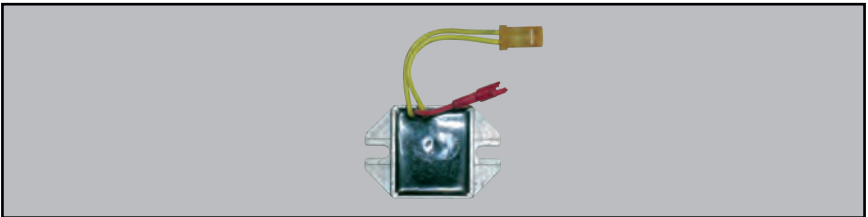

Part	Part Number
Stator	715798
Regulator	691185
Connector	399916

10 Amp Regulated

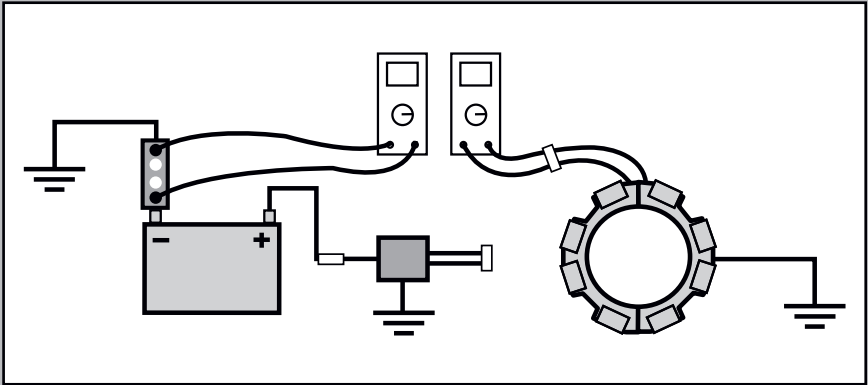
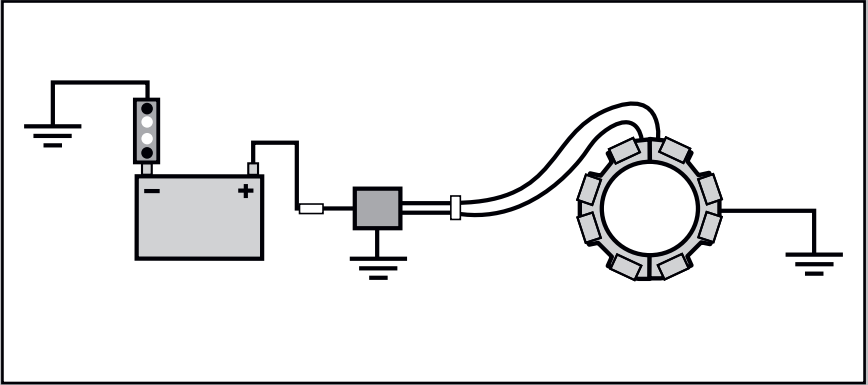

Test Specifications @ 3600 rpm

AC volts	20 vac
DC amps at shunt	1→10 adc

10, 13 or 16 Amp Regulated

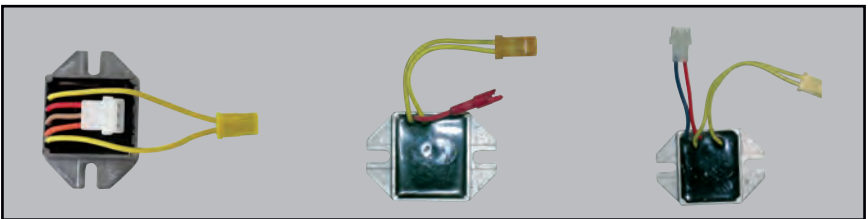
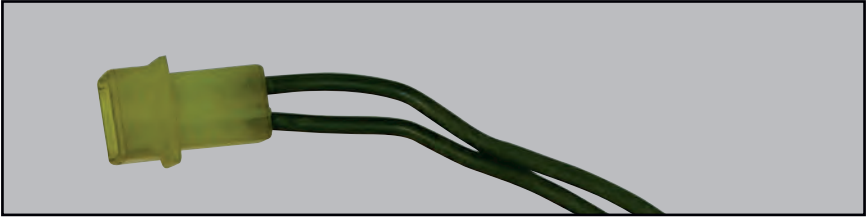

Part	Part Number
Stator	696458
Regulator*	808877
Regulator**	691185
Regulator***	493219

*Brown and orange wire go to charge indicator device.

**10, 13 or 16 amps based on flywheel magnet size

***Blue wire is for a charge indicator light

10, 13 or 16 Amp Regulated

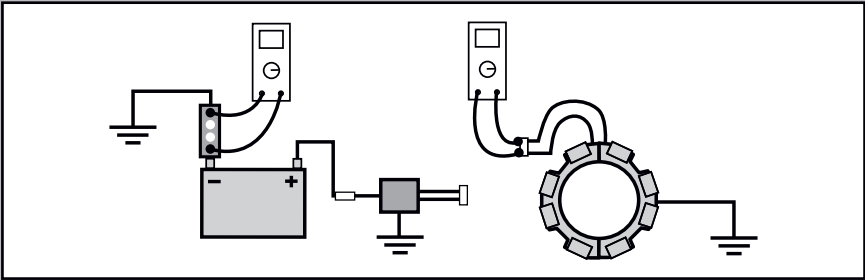
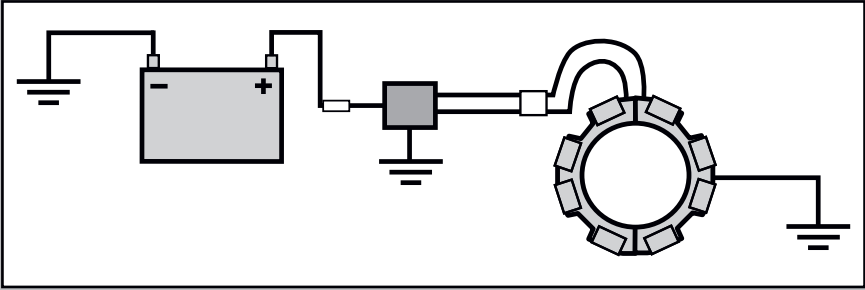

Rd=Charge lead
Brn=Charge indicator light

Blue=Charge indicator light

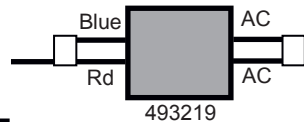
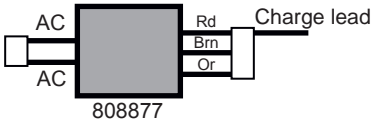

NOTE: Connect red to orange to turn the system on and to test output.

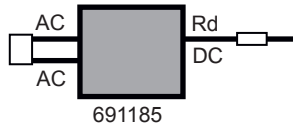

Test Specifications @ 3600 rpm

10 Amp	
AC volts	20 vac
DC amps at shunt	1→10 adc
13 Amp	
AC volts	20 vac
DC amps at shunt	1→13 adc
16 Amp	
AC volts	30 vac
DC amps at shunt	1→16 adc

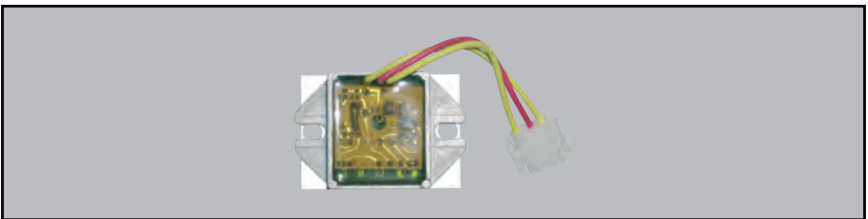
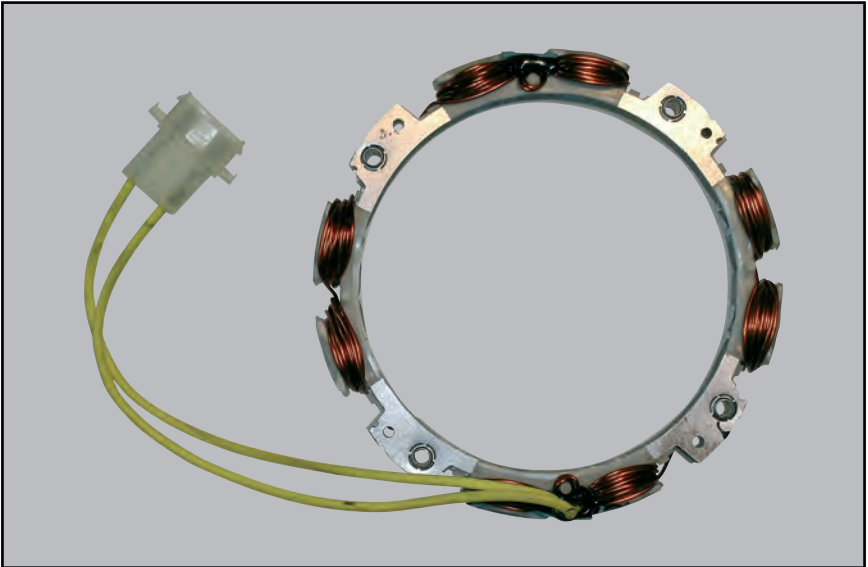
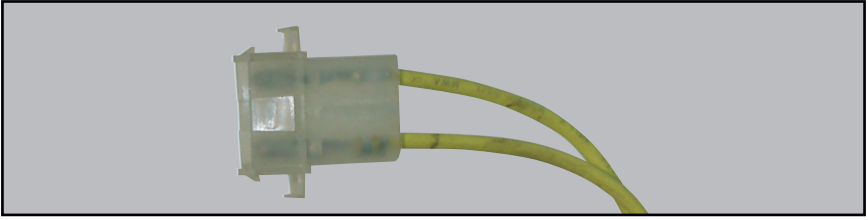

Part	Part Number
Stator	696579
Regulator	691573
Charge wire	691362

20 Amp Regulated

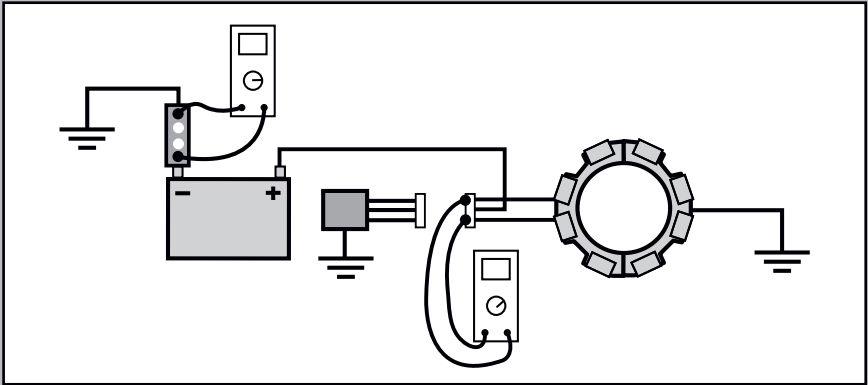
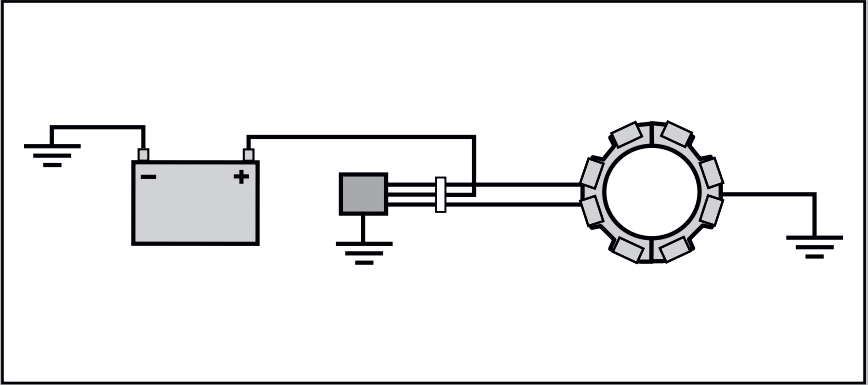

Test Specifications @ 3600 rpm

AC volts	29 vac
DC amps at shunt	1→20 adc

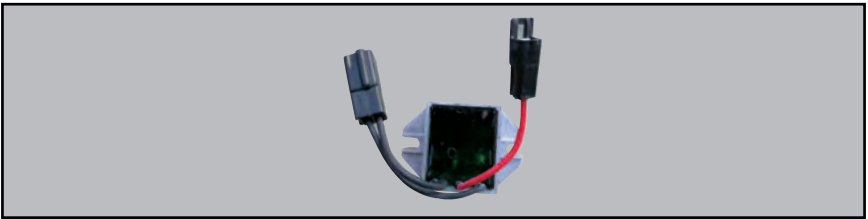
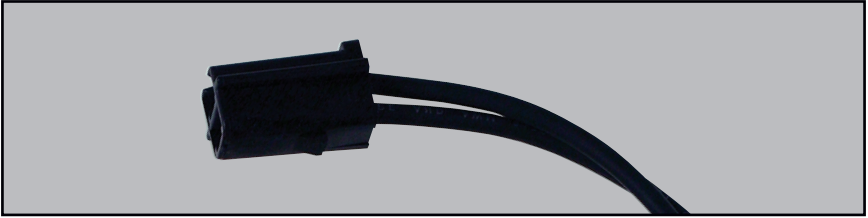

Part	Part Number
Stator	790320
Regulator	790325

20 Amp Regulated

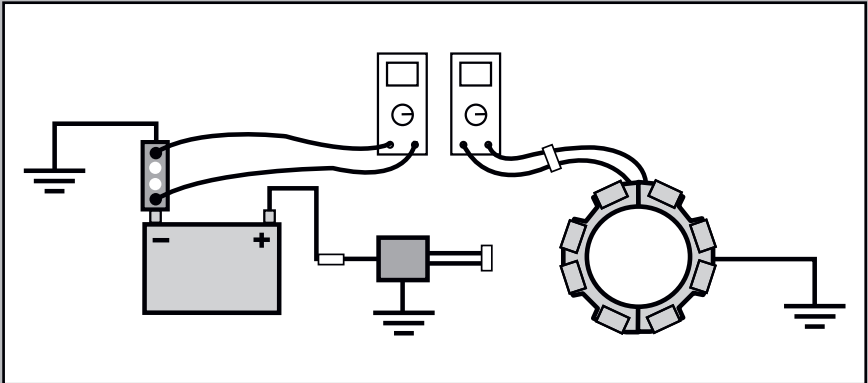
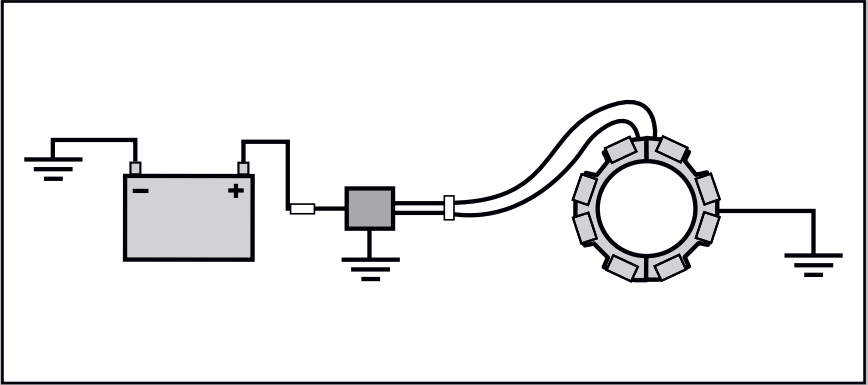

Test Specifications @ 3600 rpm

AC volts	30 vac
DC amps at shunt	1→20 adc

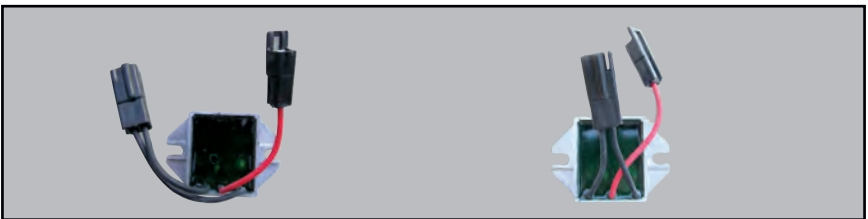

Part	Part Number
Stator	795498
Regulator	790325
Regulator	793660

20 Amp Regulated

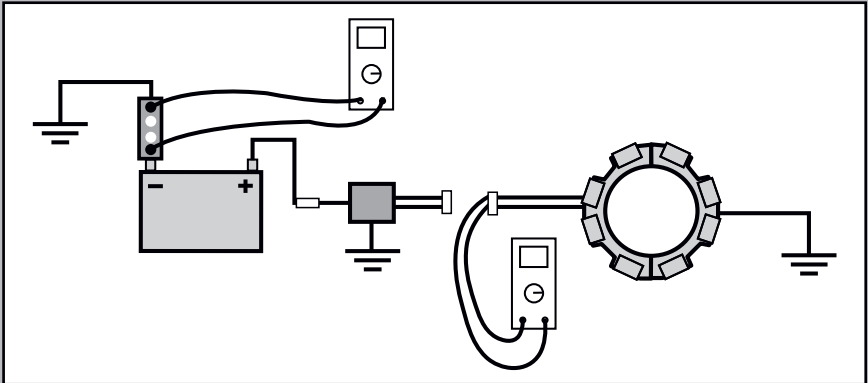
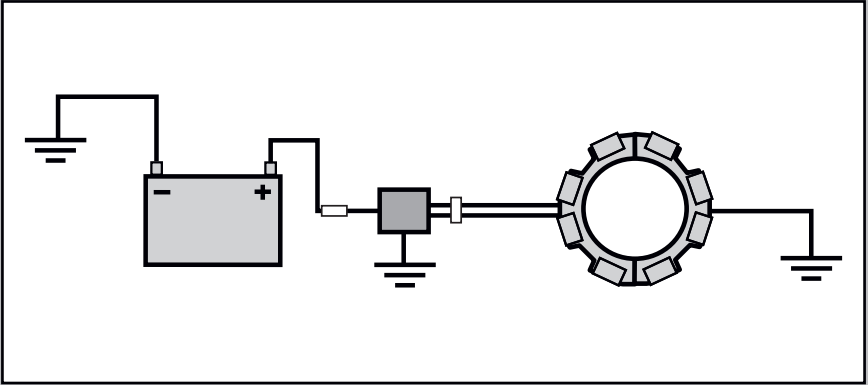

Test Specifications @ 3600 rpm

AC volts	30 vac
DC amps at shunt	1→20 adc

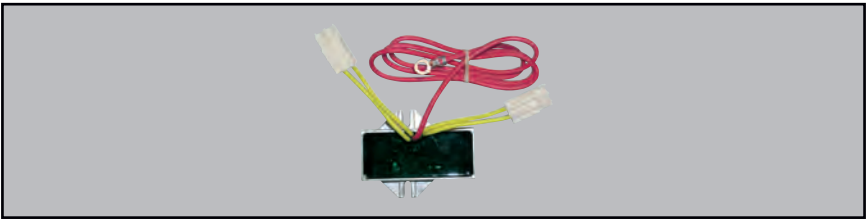
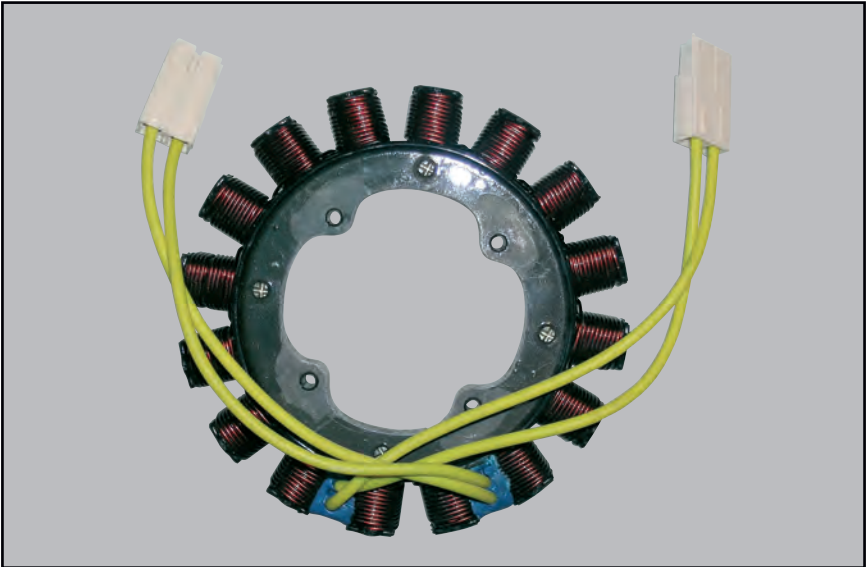
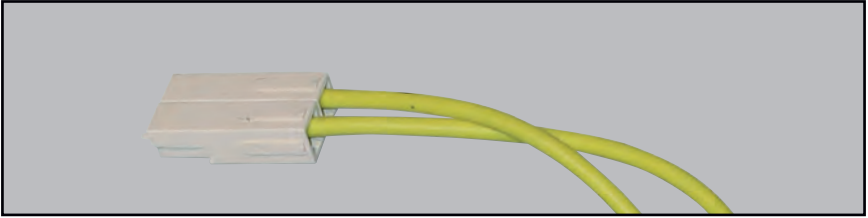

Part	Part Number
Stator	841178
Regulator	841170

20-50 Amp Regulated

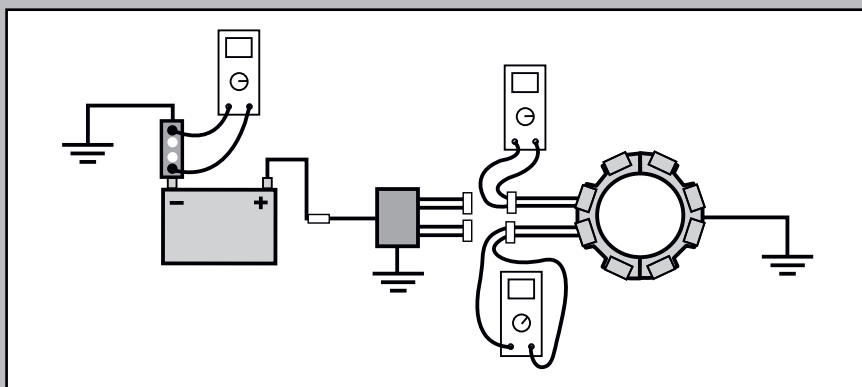
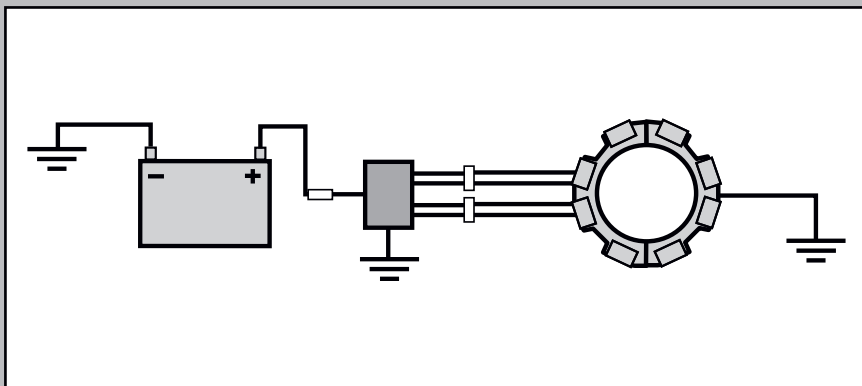

Test Specifications @ 3600 rpm

AC volts	45-50 vac
AC volts	45-50 vac
DC amps at shunt	3→50 adc



MS-0415 ENGINE ALTERNATOR REPOWER GUIDE

Many of you have used this alternator replacement guide to help repower equipment that use alternator systems different from the original specification. We have recently begun to upgrade this guide to better reflect the many questions that we receive from the field. Please note that this guide can be downloaded from The Power Portal website and printed for FREE. If you would like a hard copy please order MS-0415 from your source of supply.

Kit



19615 REPOWER TERMINAL KIT

This Engine Repower Terminal Kit will equip you to handle almost any electrical connector or terminal service work on nearly any engine. The generous selection of connectors and terminals provides you with the necessary components to help perform equipment repower. This Engine Repower Terminal Kit is designed to be used in the shop or out in the field. Assembled in a durable case with an easy to follow chart showing the parts, part numbers, quantities and bin locations, the kit offers 5 empty bins so you can add or store any of your important electrical components or tools. All components are replaceable and can be ordered individually. This kit is a great addition to your service repair supplies.



MS2288bk 6/11

BRIGGS&STRATTON
CORPORATION

CUSTOMER EDUCATION
POST OFFICE BOX 702
MILWAUKEE, WI 53201 USA
800 934 7730 | cust.ed@basco.com
Copyright ©2011. All rights reserved.